



Grooming Mowers

Rear Discharge - All-Flex - Flail Mowers



MOWER INDEX

AFM4014/16 All-Flex Mower	12
AFM4211 All-Flex Mower	10
AFM4522 All-Flex Mower	14
All-Flex Mower Specifications	16
FDR16 Series Rear Discharge	4
FDR25 Series Rear Discharge	6
FDR35 Series Rear Discharge	8
Grooming Mower Specifications	9
FM20 Series Flail Mowers	17
FM31 Series Flail Mowers	18
FM41 Series Flail Mowers	19
Flail Mower Specifications	19

www.landpride.com

2



*BLADE CHOICES FOR ALL LAND PRIDE GROOMING MOWERS

1 - Low Lift

Highly recommended in sandy soils where lifting isn't crucial. Disturbs the soil very little, allowing blades to wear longer.

2 - Medium Lift

Medium suction for lifting grass. Requires less HP than high lift.

3 - High Lift

Greatest suction for lifting grass before cutting. Can take higher HP in tall dense grass. Not recommended in sandy soils.

4 - Mulching

Perfect for leaf mulching.



* Blade choice beyond standard equipment available through Parts Department.

For a super finish start with Land Pride.

Land Pride 3-Point Grooming Mowers leave your grounds with a professional appearance, comparable to walk behind mowers, but you can get the job done in a lot less time.

Land Pride Grooming Mowers feature floating 3-point systems allowing the mower to maintain proper cutting height through uneven terrain. Our Rear Discharge decks are ideal for the frequent mower, leaving grass clippings right behind the mower and not discharged into unwanted areas. The strength of our mowers comes from our "frame" design. The four wheeled frame carries the mower deck, and takes the shock loads from uneven ground, putting less stress on the deck itself.

From start to finish, Land Pride Grooming Mowers provide a professionally clean-cut look every time.

Land Pride Quick-Hitch Systems, available in a Cat. 1 and Cat. 2 Tractor 3-Point Hitch or Cat. 1 or 2 non-PTO Skid Steer Hitch, fit most Land Pride products and are a real time saver when working on multiple projects. Look for the Quick-Hitch System logo to denote applicable products.



New Available Colors!



Buckskin

Green

Orange

Red

Blue

Many products are available in colors to match your tractor. See the legend next to the model number throughout this catalog for color availability.

GROOMING MOWERS

Leave a nice, clean cut with Rear Discharge.

Large lawns, estate mowing or small parks can all be groomed like a professional. The wide open Rear Discharge disperses grass like no other. The design of the deck keeps the material moving, so when discharged, it leaves a nice cleanly cut appearance.



Floating top link and lower clevises allow mower to follow uneven contours, reducing the chance for scalping.



Chains are not needed on the rear discharge area due to the design of the deck. Rear chains catch cut grass and allow unsightly dead clumps.

Patented Deck Design

Engineered for maximum air flow for superb distribution of clippings, our patented design is identical to our commercial model.



Rear discharge mowers perform best in well maintained areas. Grass reacts better to cutting when no more than 1/3 of the grass blade is removed. When more needs to be removed, consider mowing using multiple passes.

Which Discharge Mower is right for you?

SUGGESTED HORSEPOWER

16
SERIES
15 - 30 HP

25
SERIES
15 - 50 HP

35
SERIES
25 - 60 HP

Designed for the homeowner!

Land Pride's Patriot® Series Rear Discharge Grooming Mowers offer features and benefits that satisfy the most particular users. Our unique tapered rear design does away with chains that tend to clump damp grass and leave it lying in piles. Our wide, even dispersal leaves grass in a fine thin layer directly behind the mower. This is especially beneficial if you are not wanting to blow grass in unwanted areas, like streets or flowerbeds.

THE PATRIOT Series

www.landpride.com

FDR16 SERIES

Available in:



15 - 30 HP — 48", 60", 72"

5 year
Limited
Gearbox Warranty*

QUICK HITCH

(60" & 72" only)

- Cat. 1 Hitch
- 3/16" deck thickness
- Two position top hitch allows for various tractor lift capabilities
- Floating 3-point for ground following capabilities
- Adjustable clevis hitch for easy hook-up
- Medium lift, heat treated blades
- Solid rubber tires
- 1" Wheel spindles with nylon bushings for smooth casting
- Single B-section belt with Kevlar
- High blade tip speed
- 1 1/4" Blade overlap



GROOMING MOWERS



Designed and built with homeowners in mind, the Patriot is just right for subcompact and compact tractors found on the outskirts of any city. With our tapered rear design discharge area, foreign objects are discharged closer to the ground, plus you can mow close to objects with either side of the mower.



The driveline storage hook keeps the driveline off the ground when not in use.

Available in 3 widths, the Patriot Rear Discharge Grooming Mower fits a wide range of tractors. From one acre to many acres, our high blade tip speed, floating hitch, and efficient discharge will give you the best cut in the neighborhood!

5

Floating lower clevises allow the mower to cut evenly over uneven terrain. The clevis allows for easy attachment to the tractor, and can be adjusted to accommodate different tractor sizes.

Easily change cutting height with long lasting plated spacers on each gauge wheel. Gauge wheel spindle shafts are greaseable for trouble free casting, even on soft turf.



We're up front about our Rear Discharge Mowers. They're superb!

FDR25 SERIES

15 - 50 HP — 72", 84"

Available in:



5 year
Limited
Gearbox Warranty*

Quick Hitch

- Cat. 1 Hitch
- 3/16" Deck thickness
- Lower hitch clevises adjust in and out for greater leverage
- Floating 3-point for superior ground hugging capabilities
- Non-corrosive plated spacers to change cutting height from 1"– 5 1/2"
- Solid rubber tires on 72" model
- Semi-solid tires on 84" model
- 1" Wheel spindles with nylon bushings for smooth casting
- 3 Medium lift heat treated blades
- High blade tip speed
- 1" Machined blade spindle with ball bearings and cast iron housing
- Single B-section Kevlar belt, spring loaded for maximum performance
- Driveline storage hook



Rounded front corner without lip helps protect trees and fences.

Rear discharge mowers require higher horsepower, especially in tall, dense grass. For maximum performance, use in regularly maintained areas.



Blade spindles and bearings are precision fit in a cast iron housing.



Grease bearings from top without removing belt covers.

We'll even stand behind it!

We've long been looked upon as a leader in 3-Point Grooming Mowers. Our mowers have been copied by others, but we will continue to lead through innovation and design. Our FDR25 Series Rear Discharge Mower is built tough for tough jobs and long days. Discharging grass out the rear of the mower is what people want; it leaves a clean cut, it doesn't discharge debris high in the air, it discharges grass evenly over a wide surface, and it doesn't discharge into unwanted areas. And it's a product we back with a 5 year limited gearbox warranty!

- Working widths to match most needs and tractor tire spacing.
- A 3-point hitch that floats and adjusts to fit various tractor hitch and tire combinations.
- A top link that features two settings to adjust to various tractor lift capabilities.



3/8" Gearbox support channel handles high stress loads.

Greaseable wheel bearings and spindle shaft allows for smooth rolling and turning.

Main drive cast iron pulley offers superior strength and belt slippage control in all types of mowing conditions.



Solid rubber tires on 72" model are sandwiched between the rim halves and bolted in.

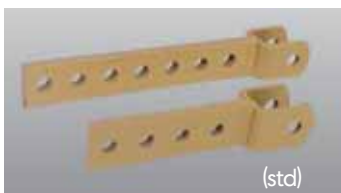

Some tractor and tire combinations do not allow enough room for the mower hook-up. Longer lower hitch clevises are available to easily correct this situation.



Steel chassis — The all welded steel chassis forms a single integrated unit designed to support the mowing deck and to absorb shock loads incurred by the wheels and the front of the deck.



5/16" Front edge support protects deck

Land Pride's unique baffling system performs with results to make professionals smile. Strategically located to maximize air flow for clean distribution, yet minimize grass obstruction, our underside deck design is simple, yet very effective.

The FDR3590 is pure muscle! Designed to take heavy commercial use, the 90" width can swallow a lot of grass in one bite. Our rear discharge area tapers down, keeping flying debris close to the ground. The strong, thick blades turn at 18,500 fpm, powered by a gearbox to match all-out performance.



FDR35 SERIES

Available in:



25 - 60 HP — 90"

5 year
Limited
Gearbox Warranty*

QUICK HITCH

- Cat. 1 Hitch
- Floating 3-point
- Clevis hitches for easy one person hook-up
- 3/16" Deck material
- 1/4" Wall gauge wheel arm
- 13" Semi-solid tires
- 3/4" - 5 1/4" Cutting height
- Spring loaded adjustable idler
- 18,500 fpm Blade tip speed
- Top greaseable blade spindles with ball bearings
- 2 1/4" Blade overlap
- 5/16" Medium lift blades
- Greaseable wheel bearings and spindle
- Spring loaded belt tensioner for trouble-free performance

Commercial Grade Features

- 1 1/2" Blade spindle made from stress proof material
- Keyed pulley for slippage control
- C-section drive belt
- 1 1/4" Gauge wheel shaft
- Optional front roller



GROOMING MOWERS



Rear Discharge Grooming Mower Specifications

Model Number	FDR1648	FDR1660	FDR1672	FDR2572	FDR2584	FDR3590
Max. Engine HP	30 HP	30 HP	30 HP	50 HP	50 HP	60 HP
Cutting Width (cm)	48" (122)	60" (152)	72" (183)	72" (183)	84" (213)	90" (229)
Overall Width (cm)	51" (130)	63" (160)	75" (190)	77" (196)	89" (226)	92" (234)
Weight (kg)	486 (220)	577 (262)	619 (281)	718 (326)	812 (368)	1026 (465)
Mowing Height (mm)	3/4" - 3 1/4" (19 - 83)	3/4" - 5 1/4" (19 - 133)		3/4" - 5 1/4" (19 - 133)		3/4" - 5 1/4" (19 - 133)
Deck Material Thickness (mm)	3/16" (4.7)		3/16" (4.7)		3/16" (4.7)	
Blades (mm) 3 ea. Heat Treated Alloy Steel	1/4" x 2 1/2" x 16 3/4" (6.35 x 63.5 x 425)	1/4" x 2 1/2" x 20 3/4" (6.35 x 63.5 x 527)	1/4" x 2 1/2" x 25 3/4" (6.35 x 63.5 x 654)	1/4" x 2 1/2" x 25" (6.35 x 63.5 x 635)	5/16" x 2 1/2" x 29" (7.94 x 63.5 x 736.6)	5/16" x 2 1/2" x 31 1/2" (7.94 x 63.5 x 800)
Blade Overlap (mm)	1 1/4" (32)		1 1/4" (31.8)		2 1/4" (57.2)	
Blade Spindles	Greaseable		Greaseable		Greaseable	
Blade Tip Speed	16,203 FPM	18,195 FPM	18,130 FPM	18,130 FPM	17,210 FPM	18,500 FPM
Hitch	Cat. I		Cat. I		Cat. I	
Gauge Wheels (cm) 4-each	3 1/4" x 10" (8.2 x 25.4) solid rubber tire		3 1/4" x 10" (8.2 x 25.4) solid rubber tire		4" x 11" semi-solid	
Wheel Spindle (mm)	1" (25) diameter		1" (25) diameter		1 1/4" (32) diameter	
Drive Train	540 RPM B-Section V-Belt		540 RPM B-Section V-Belt		540 RPM C-Section V-Belt	
Driveline	Heavy-duty w/quick coupler		Heavy-duty w/quick coupler		Heavy-duty w/quick coupler	
Front roller	Optional		Optional		Optional	

* See dealer for complete warranty information.

Models may or may not include options.
Design and specifications subject to change without notice.

Unmatched Performance.

A mower that gives a commanding performance, in a very versatile size, and costs thousands less than a self contained out front type mower.

Many smaller golf courses or cities cannot afford a self contained out front type mower. A compact tractor and 11' All-Flex Mower can cost thousands less, and you don't hold your tractor hostage! You can use your tractor for many other implements instead of just a mowing machine; now your tractor is an even better investment.

An 11' AFM is just right to use around the golf course, in the city park, or to maintain your 5 acre estate. Easy to use and maintain, keep your grass looking like it was cut with a walk-behind, but with a lot less time invested in doing so!

www.landpride.com

AFM4211 SERIES

30 - 65 HP — 11'

Available in:



- 11' 1" Cutting width
- Three 48" decks; 3/16" thickness
- Narrow 5' 6" transport width
- 6" Deck overlap eliminates skipping
- Automatic wing locks for transport
- Zero turning radius due to sleek frame design
- Mowing height: 1" to 5 1/2"
- Rear discharge for even dispersal
- 13" Deck tires with sealant
- 18" Transport tires with tapered bearings
- 16,260 fpm Blade tip speed
- Anti-scalp rollers
- Easy to grease from top blade spindles
- See page 2 for blade choices

Which All-Flex Mower is right for you ?

SUGGESTED HORSEPOWER

11' MODEL	14' MODEL	16' MODEL	22' MODEL
30 - 65 HP	40 - 70 HP	45 - 70 HP	65 - 100 HP

Front and rear deck tires do not travel in the same path.

Clippings from this deck go that way.

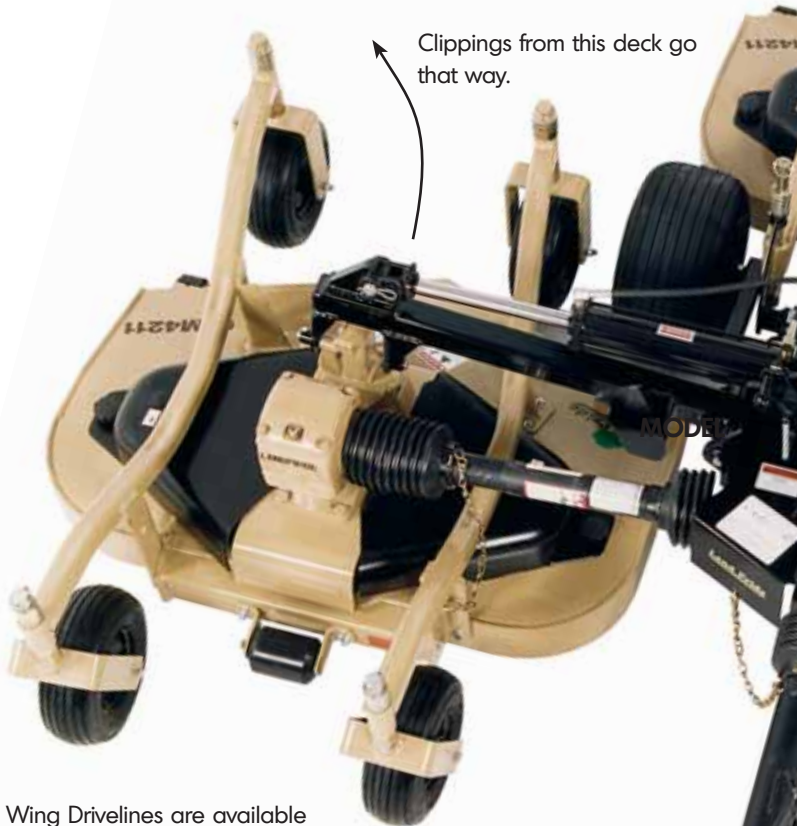

Wing Drivelines are available with optional slip-clutches.

Main driveline features a Constant Velocity U-joint to reduce chatter during tight turns.

Single beam hitch allows for "zero turn" negotiations.



All AFM's feature square shafts on rear wheels of wing decks keeping tires straight at all times, eliminating side-hill creeping.



All AFM's feature 1/4" wall gauge wheel arms.



Rear deck stays clean of clippings from wing decks.

Clippings from this deck go that way.



Rear wheels of each wing deck do not caster. When situated side ways on a slope, the non-castering wheels help hold your ground.

Wing arms are 1/4" wall sq. tubing for added strength.

Rounded front deck edges and no protruding skid shoe helps protect trees and other obstacles.



3/8" steel gearbox support channel can handle high start-up torque.

5/16" front edge and all-welded seam for extra durability.



Low deck pivot allows for greater side to side flotation on the wing decks.



Over center release easily takes tension off the drive belt during extended off time.



Dispensing cut grass is a key ingredient to maintaining healthy turf. The more evenly and completely the cut grass is dispersed, the quicker it works its way towards the soil for decomposition.

All-Flex Mowers.

Our name says it all!

Maintaining a large area of grass in a picturesque setting is a tough job. Look to our All-Flex Mowers to give you the results you deserve. Lush turf-type grass can be demanding on a mower, but with features found in our All-Flex Mowers, you can take a wide cut and spend more time enjoying the fruits of your labor.

Commercial duty components are used throughout the All-Flex Mower. Built tough and rugged, yet with an air of class to match the performance and results, you'll be proud to say you made the right choice!

www.landpride.com

AFM40 SERIES

Available in:



40 - 70 HP — 14', 16'



- 6' 8" Transport width meets city requirements
- Grease blade spindles without removing guards
- Wings automatically lock for safe transport, release with pull rope
- 15" or 18" Deck tires with sealant and roller bearings for long life
- 1 1/4" Blade overlap
- Single B-section belt per deck with spring loaded belt tensioner
- Cat. 4 CV input driveline
- Cat. 2 wing drivelines with or without slip-clutches
- Anti-scalp rollers
- Rear discharge without chains. Chains collect moist grass and drop it in unsightly clumps.
- 23" Transport tires offer excellent roading capabilities
- See page 2 for blade choices
- Wing decks discharge clippings away from the rear deck
- Wing deck rear wheels are non-castering; helps hold mower on slopes
- Easily grease blade spindle at the front of each deck
- Single beam hitch and generous deck overlap virtually eliminate skipping in "zero-turn" situations



18" Gauge wheels feature bolt in spindles for ease of replacement.



Easily access grease zerks to keep drivelines operating efficiently.



Shown with 18" deck tires.

The AFM is perfect for golf course maintenance, large estates, city recreation areas and sports fields. Sleek enough to get under trees and agile enough to turn on a dime, the AFM Series is just right for all around maintenance. And the quality of cut is the best feature of all.



The front corners of each deck are reinforced to protect against hitting obstructions. Smooth outside deck construction saves trees and other obstructions.

AFM4014

- 14' Cutting width
- Three 60" decks
- 6" Deck overlap for zero turn capabilities
- 18,396 fpm Blade tip speed
- 15" or 18" deck tires

AFM4016

- 16' 8" Cutting width
- Three 72" decks
- 8" Deck overlap for zero-turn capabilities
- 18,340 fpm Blade tip speed
- 15" or 18" deck tires



Anti-scalp rollers on nose and trailing edges of decks protect the deck as well as the turf.



Low deck pivot allows for greater side to side flotation on the wing decks.



Over center release easily takes tension off the drive belts during extended off time.

Wide open spaces . . .

Time is money to most people. If you're mowing just to keep the grass manicured or you're mowing to eventually harvest the turf, your time is worth a great deal in many ways. Keeping your labor time to a minimum is important, regardless of why you are cutting.

Our 22' All-Flex Mower is ideal for those wide open spaces. Cutting a 22' swath takes a bite out of any workload, while leaving behind a professionally performed job.

AFM45 SERIES

65 - 100 HP — 22'

2 year
Limited
Gearbox Warranty

- Three 90" decks
- 6" Deck overlap allows for tight turns and no skips
- Change deck height with spacer collars in 1/4" increments
- Anti-scalp rollers on each deck reduces turf damage
- 18" Deck tires with foam sealant mean fewer pounds per square inch
- Cat. 4 CV main driveline allows for tight turns and no driveline chatter
- Cat. 3 deck drivelines with slip-clutch protects gearboxes against high torque start-ups
- Single C-section belt per deck with spring loaded belt tensioner
- 4 Gauge wheels per wing for maximum flotation
- Single beam tongue for zero turning radius
- 18,498 fpm Blade tip speed ensures a clean, even cut
- 1/4" Sidewall thickness on gauge wheel arms means a great deal of "hidden" strength
- Wings automatically lock for safe transport
- Rear discharge decks for even dispersal
- Adjustable clevis hitch to fit various draw bar heights
- See page 2 for blade choices
- Our rear discharge decks are designed to be used without chains. Chains collect moist grass that drops off in clumps, which turn brown and unsightly.



Transport width of 9'6" allows for safe transport from site to site.



All AFM's feature 1/4" wall gauge wheel arms.





Gauge wheels feature bolt in spindles for ease of replacement, and 18" tires leaving a light weight footprint.

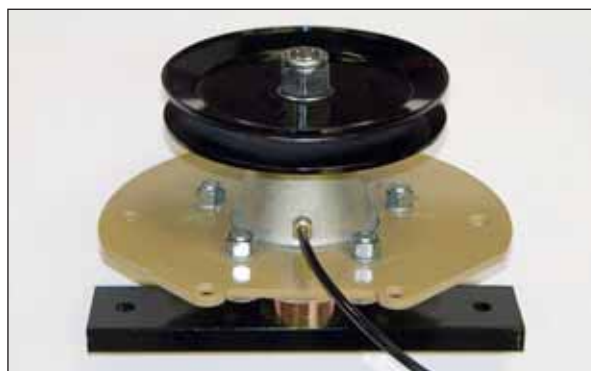

The commercial duty 1 3/8" blade spindle features a cast iron housing, additional steel plate support, a 3/4" thick blade support bar and a remote greasing line.

Easy to use.

22' of mower is a lot to pull behind you. But think of it as 3 - 90" decks, and it doesn't sound so complicated! Each deck performs independently of the others. Each deck can float side to side and front to back. Undulations are easily negotiated by the 18" deck tires and the anti-scalp rollers. The commercial duty 90" wing decks are held in place by the heavy-duty wing arms built specifically for our 22' size.

Getting the 3 big decks going all at once is a big chore. A great deal of torque is transmitted from the tractor to get all the blades in motion. That is why we use drivelines with slip-clutch protection, cast iron gearboxes with high quality seals and bearings, and a 3/8" steel plate to support the gearbox.



All AFM's feature blade spindles and bearings precision fit in a cast iron housing.

- 27" Automotive tires for dependable roading.
- Top and bottom bearings on 1 5/8" stress proof blade spindle.
- 5/16" Blade is attached to a 3/4" x 2 1/4" blade support.

All-Flex Grooming Mower Specifications

Model No.	AFM4211	AFM4014	AFM4016	AFM4522
Cutting Width (cm)	11' 1" (337.82)	14' (426.72)	16' 8" (508)	21' 9" (662.94)
Overall Width (cm)	11' 3-1/2" (344.17)	14' 3" (434.34)	16' 10" (513.8)	22' (670.56)
Transport Width (cm)	5' 6" (167.64)	6' 8" (203.20)	6' 8" (203.20)	9' 6" (289.56)
Hitch	Pull type, Adjustable Clevis and safety tow chain			
Positive Tongue Weight (kg)	450 lbs. (204.12)	540 lbs. (244.94)	580 lbs. (263.09)	740 lbs. (335.66)
Weight (kg)	2040 lbs. (918)	2560 lbs. (1163.63)	3100 lbs. (1406.16)	4150 lbs. (1886.36)
Cutting Height (cm)	1" - 5-1/2" in 1/2" incr. (25.4 - 139)	3/4" - 5-1/4" in 1/4" incr. (19 - 133)		
Wing Cylinders	2-1/2" x 12"		3-1/2" x 12"	
Rear Deck Cylinder (cm)	2" x 8" (5.08 x 20.32)	2-1/2" x 8" (6.35 x 20.32)		
Gearbox	540 RPM, 3 wing, 1 splitter			
Maximum Horsepower	65 HP	70 HP	70 HP	100 HP
Decks: 3 each (cm)	48" (121.92)	60" (152.40)	72" (182.88)	90" (228.60)
Deck Thickness (mm)	3/16" (4.7)			
Deck Overlap (cm)	6" (15.24)		8" (20.32)	4-1/2" (11.43)
Blade Hub	4 bolt casting			5 bolt casting
Blade Bearings	Greaseable ball bearings			
Spindle Bearing Dia. (cm)	1-3/16" (2.06)			1-1/4" (3.17) top, 1-3/8" (3.49) bottom
Blade Spindle RPM	3,668 RPM	3,362 RPM	2,802 RPM	2,241 RPM
Blade Tip Speed	16,260 fpm (184 mph)	18,396 fpm (209 mph)	18,340 fpm (208 mph)	18,498 fpm (210 mph)
Blade Size (mm)	1/4" (6.35) x 2-1/2" (63.5) x 16-3/4" (425)	1/4" (6.35) x 2-1/2" (63.5) x 20-29/32" (531.1)	1/4" (6.35) x 2-1/2" (63.5) x 25" (635.2)	5/16" (7.94) x 2-1/2" (63.5) x 31-17/32" (801.1)
Blade Overlap (cm)	1-3/16" (3.01)	1-1/4" (3.17)		2-1/4" (5.72)
Discharge	Rear			
Blade Drive Belt	1 B-section			1 C-section
Input Driveline	Cat. 3 CV		Cat. 4 CV	
Deck Driveline	Cat. 2 w/ or w/o slip-clutch			Cat. 3 w/slip-clutch
Deck Tires - 10 ea.	13 x 5 Air Tire, Sealant	15 x 6.6 Air Tire, Sealant or 18 x 9.5 Air Tire, Sealant		18 x 9.5 Air Tire, Sealant
Deck Wheel Spindles (cm)	1-1/4" (3.17) w/Nylon Bushings			
Transport Tires and Bearing	18 x 9.5, Sealant Tapered Bearings	23 x 10.5, Sealant Tapered Bearings		P27560SR Tapered Bearings
Anti-Scalp Roller	Front Center and Outside Deck Corners			Front Center of Each Deck
Mowing cap. (m ²) @2mph	2.68 acres (10.85)	3.39 acres (13.72)	4.0 acres (16.19)	5.27 acres (21.33)
@4mph	5.37 acres (21.37)	6.78 acres (27.44)	8.1 acres (32.78)	10.54 acres (42.65)
@6mph	8.1 acres (32.73)	10.17 acres (41.16)	12.1 acres (48.97)	15.82 acres (64.02)
Flex-Wings	23° L-R, 22° F-B	23° L-R, 22° F-B	23° L-R, 22° F-B	23° L-R, 22° F-B
Flex Center	13° F-B	10° L-R, 22° F-B	10° L-R, 22° F-B	10° L-R, 22° F-B



FLAIL MOWERS

Fast, clean and dependable mowing.

Land Pride Flail Mowers are the perfect choice for schools and other recreational areas where people may be present. With the rotor working in the opposite direction of travel, the cut grass is brought up and over the rotor. Most clippings are laid down prior to the mower passing it by, which means foreign objects also have a tendency to stay inside the mower and are less likely to be discharged.

Which Flail Mower is right for you?

SUGGESTED HORSEPOWER

20

SERIES

25 - 55 HP

31

SERIES

35 - 80 HP

41

SERIES

35 - 80 HP



The unique three blade system on the 20 Series Flail Mower gives a nice even cut.



FM20 SERIES

25 - 55 HP — 60", 72"

- 1" Cutting capacity
- 0-4" Cutting height
- Rear height adjusting roller with greaseable bearings
- Scraper on rear height adjusting roller
- Fine cut knives
- 4-1/4" Rotor diameter
- Reverse rotor rotation
- Cat. 4 driveline
- 11 ga. Deck thickness
- 2 Position hitch for offsetting
- Replaceable skid shoes
- Fenders on both ends to protect trees

The 20 Series Flail Mower offers a two position hitch for offsetting the mower, enabling closer cutting along buildings, fences or roadsides.



Tapered ends on rear roller prevent gouging during tight turns.

Tough machine offering fine results.

Our 31 Series Flail Mowers feature the same tough components as our 41 Series, but with blades offering a fine cut.

The perfect model for mowing around schools and municipalities, the 31 Series has a mostly enclosed structure to keep the cut grass and other debris within the cutting chamber. The rear roller, which acts as the cutting height gauge, has tapered ends to eliminate gouging during tight maneuvers. A formed scraper keeps the roller clean from moist grass and mud, so cutting height is not disturbed.

The slotted top hitch point allows the mower to float over undulations.

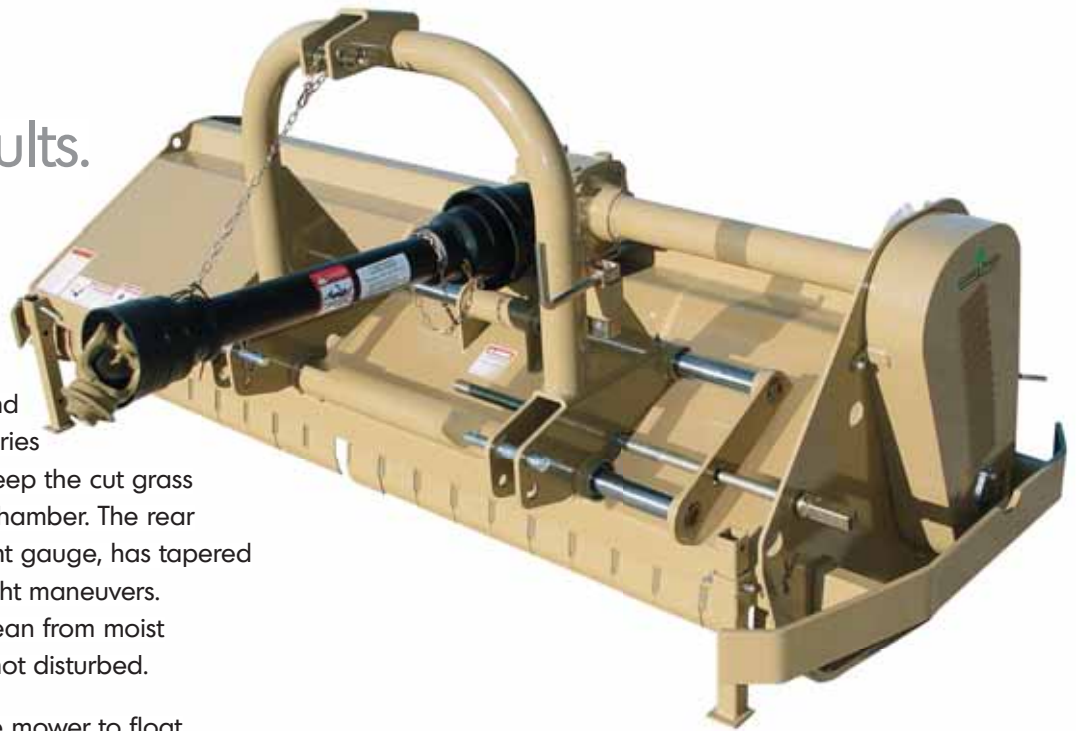

www.landpride.com

18

FM31 SERIES

35 - 80 HP — 88"

- 1" Cutting capacity
- 1/2" - 6" Cutting height
- Rear height adjusting roller with greaseable bearings and tapered ends to prevent gouging during turns
- Scraper on rear height adjusting roller
- Fine cut knives
- 5-1/2" Rotor diameter
- Reverse rotor rotation
- Cat. 4 driveline
- 3/16" Deck thickness
- Hitch offsets by nearly 8"
- Hinged rear gate allows opening for maximum dispersal of heavy clippings
- Replaceable skid shoes
- Fenders on both ends to protect trees
- Three 'C' section belts for a tight positive drive
- Gearbox with built-in over-running clutch allows rotor to free-wheel to a stop



The 31 Series Flail Mower offers a two blade system resulting in a fine cut.

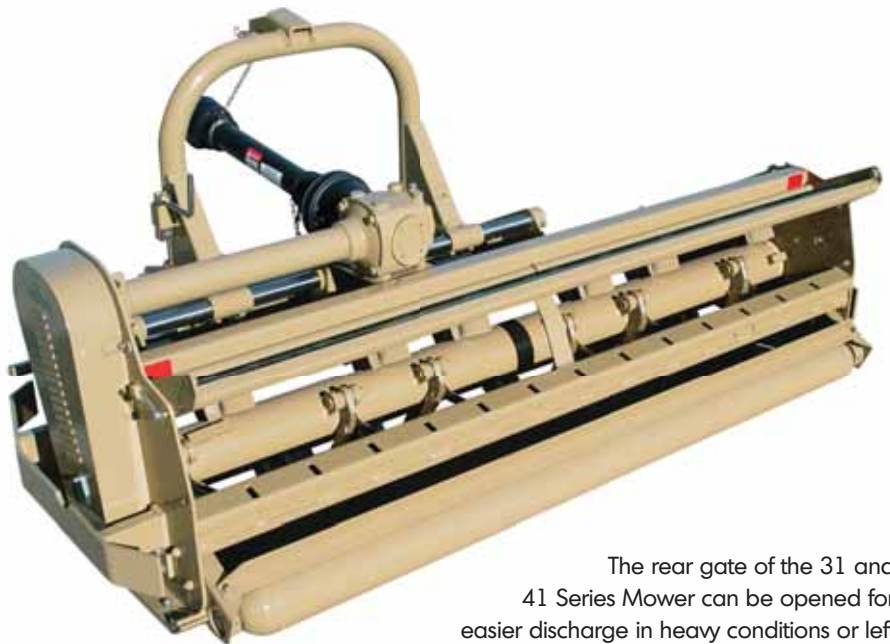

The rear gate of the 31 and 41 Series Mower can be opened for easier discharge in heavy conditions or left closed for greater mulching capabilities.

The 41 Series offers 3/16" deck material and utilizes a threaded rod to easily offset the hitch by nearly 8". The gearbox incorporates an over-running clutch that enables the rotor to swing free to a stop when the tractor PTO has been turned off. The rear gate of the mower can be opened for easier discharge in heavy conditions, or left closed for greater mulching capabilities. The 41 Series also offers heavy forged hammers and brush rake teeth.

FM41 SERIES

35 - 80 HP — 88"

- 2" Cutting capacity
- 1/2" - 6" Cutting height
- Rear height adjusting roller with greaseable bearings and tapered ends to prevent gouging during turns
- Scrapers on rear height adjusting roller
- Fine cut knives
- 5-1/2" Rotor diameter
- Reverse rotor rotation
- Cat. 4 driveline
- 3/16" Deck thickness
- Hitch offsets by nearly 8"
- Hinged rear gate allows opening for maximum dispersal of heavy clippings
- Replaceable skid shoes
- Fenders on both ends to protect trees
- Three 'C' section belts for a tight positive drive
- Gearbox with built-in over-running clutch allows rotor to free-wheel to a stop



The 41 Series features 24 forged hammers to shred prunings and to provide a nice clean cut in grass. 13 adjustable brush rake teeth also keep prunings in the blade path for maximum mulching.



(41 Series hammers)

The baffles on the top inside of the deck keep the cut material from clumping together.

Flail Mower Specifications

Model Number	FM2060	FM2072	FM3188	FM4188
Hitch	Cat. 1		Cat. 1 & 2	Cat. 1 & 2
Offset Hitch	6-1/4" Right, Centered		7-3/4" Left & Right, Screw Type	7-3/4" Left & Right, Screw Type
HP Rating - Max.	55 HP		80 HP	80 HP
Gearbox RPM	540 w/over-running clutch		540 w/ over-running clutch	540 w/ over-running clutch
Cutting Width (cm)	60" (152.4)	72" (182.88)	88" (223.52)	88" (223.52)
Cutting Height (cm)	0-4" (0-10.16)		1/2" - 6" (1.27-15.24)	1/2" - 6" (1.27-15.24)
Cutting Capacity (cm)	1" (2.54)		1" (2.54)	2" (5.08)
Weight (kg)	662 lbs. (300)	728 lbs. (330)	1,300 lbs. (590)	1,323 lbs. (600)
Knives	Fine Cut		Fine Cut	Hammers
No. of Knives (cm)	60	72	48	24
Rotor Diameter (cm)	4-1/4" (10.8)		5-1/2" (13.97)	5-1/2" (13.97)
Rotor Rotation	Reverse		Reverse	Reverse
Driveline	Cat. 4		Cat. 4	Cat. 4
Belt Type	2 'B' Section		3 'C' Section	3 'C' Section
Deck Thickness	11 Gauge		3/16"	3/16"
Brush Rake Teeth	N/A		N/A	13 each

THE LAND PRIDE COMMITMENT

Stability. Since our inception in 1986, Land Pride, A Division of Great Plains Mfg., Inc., has been a leader in grounds maintenance equipment throughout North America. Land Pride is now a leading manufacturer of tractor mounted and skid steer mounted implements including Rotary Tillers, Grooming Mowers, Seeders, Rotary Cutters, Rear Blades, Box Scrapers and Landscape Rakes in the United States.

Reliability. At Land Pride, we have earned the reputation of standing behind our products. We know how important it is for you to feel confident in purchasing products that are reliable, and to know that our support is available when assistance is needed.

Pride. We are proud to be a part of Central Kansas. Our employees come

from rural areas and agricultural backgrounds; they know and understand the products they build for you. Our commitment to our employees and to our customers shows through the quality products we provide.

Commitment. The extra steps we take to deliver our products is another sign of our commitment to you. Packaging provides added protection and efficient shipping procedures to ensure lower freight costs.

Service. You can rely on Land Pride's service after the sale. With Genuine Replacement Parts and a national and international network of dealers located in every state, you are assured that parts and service are available when and where you need them.

Safety. Our products are all designed and manufactured in compliance with the latest industry and government standards.

Support. Up-to-date literature, easy to read Operator's and Parts Manuals, and our informative web site are all available to assist you in making your next Land Pride purchase!

Great Plains Trucking. Our in-house trucking company has over 70 trucks and delivers our products throughout the United States and Canada.

Growth. With four plant locations, 24 product groups and several hundred models, Land Pride continues to expand and grow to meet the challenges of aggressive competition and a fast moving industry.

Corporate Office - Salina, KS

Abilene, KS

All-Flex Mowers, Zero Turn Mowers, Rotary Cutters, Rotary Tillers, Grooming Mowers, Post Hole Diggers, Flail Mowers and Fertilizer Spreaders

Kipp, KS

Rear Blades, Landscape Rakes, Box Scrapers, Scarifiers, Core Aerators, Disc Harrows, Plot Ranger, Quick-Hitches, Pallet Forks, Seed Bed Roller, Drag Harrow, Grading Scrapers, Straw Crimper and Ditchers

Lucas, KS

Multi-Spindle Rotary Cutters, Parallel Arm Rotary Cutters, Primary Seeders, Overseeders, Soil Pulverizers, Powered Rakes

Enterprise, KS — Utility Vehicles

Need More **INFORMATION?**

See our other catalogs for further product details and specifications.

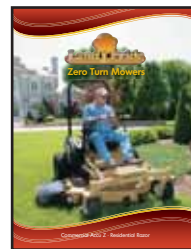
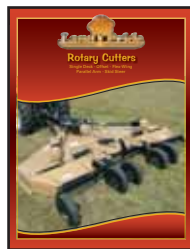
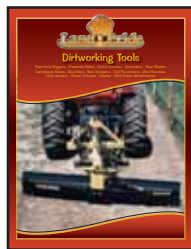
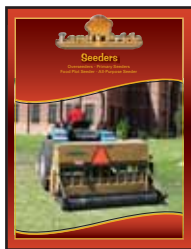
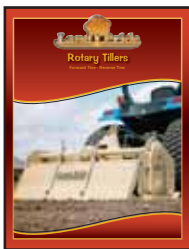
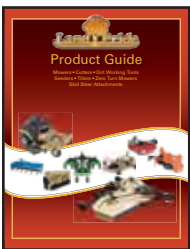

A Division of Great Plains Mfg., Inc.
1525 E. North St. • P.O. Box 5060
Salina, Kansas 67401
Visit our dealer locator at landpride.com